

Index

I.Specification of PC Diagnostic Cards.....	2
1. Notice.....	2
2. Product Introduction In Brief.....	2
3. Functional Characteristics.....	3
4. Type Characteristics.....	4
5. Operation Flow.....	5
6. Must-Reads of Users.....	6
7. Hexadecimal Characters and Particular Characters of Our Cards.....	10
8. Meanings of POST codes.....	10
AMI.....	10
AWARD.....	18
Phoenix.....	22
9. Description of beep code.....	28
10. Common Problems & Solutions.....	29
II. Detailed Specification of Diagnostics & Stability-Test Card.....	34
(1) Figure of Diagnostics & Stability-Test Card Components (MKCP6 for example).....	34
(2) Figure of Connection to Main Board.....	34
2. Differences and Functional Characteristics of Diagnostics & Stability-Test Cards and Common Analyzer Cards.....	35
3. Explanation of Diagnostics & Stability-Test Card Indicator.....	36
4. Testing Status.....	36
5. Notice.....	36

I.Specification of PC Diagnostic Cards

1. Notice

Notice : Only use this product with guidance of this instruction and under the endurance of it. The safety grading of this product accords with the IEC 61010-1 (2001) .EN 61010-1 (2001) standards and it has got the international CE certificate. The safety environment for this product is as below: indoor circumstance; operating temperature and relative humidity (non-condensing) $\leq 10^{\circ}\text{C}$, $11^{\circ}\text{C} \sim 30^{\circ}\text{C}$ ($\leq 80\%$ relative humidity), $31^{\circ}\text{C} \sim 40^{\circ}\text{C}$ ($\leq 75\%$ relative humidity), $41^{\circ}\text{C} \sim 50^{\circ}\text{C}$ ($\leq 45\%$ relative humidity); storage temperature and relative humidity: $-20^{\circ}\text{C} \sim 60^{\circ}\text{C}$ ($0 \sim 80\%$ relative humidity).

The length of warranty of our PC Diagnostic Cards is one year. Please contact our factory immediately for return and change of products if they work wrong during this period, except usage beyond the length of warranty, torn or unsealed facing slip, incorrectly usage without the guidance of this manual, damage by drop and collision or force majeure.

2. Product Introduction In Brief

1. Product Appearance (KLPI6-SD for example)

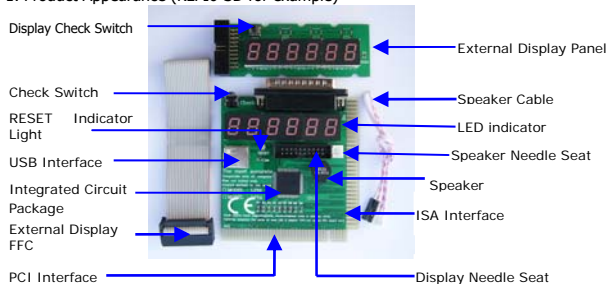

Notice: This is the typical configuration with nearly all components and functions, of which the real configuration can be designed according to different types and individual demand.

2. Part of Working Principle of POST Code

It tests and diagnoses the target by internal intelligent programs and displays

all results by codes. With the meaning explanation of the POST codes of this manual, the users can find out what are the problems quickly. Especially when the PC operating system fails to start, the screen is blank, or the buzzer doesn't work, the advantages of using this card is obvious! It will help you solve the complicated problems easily and efficiently.

Each time when the PC is boosting, the intelligent program will test all components such as circuit, memory, keyboard, display system, hard disks and floppy drive strictly, analyze the system configuration and initialize the basic I/O setting automatically. If every part works normally, the system will keep on. It tests the key components first and forces the PC to halt if there is failure, the cursor will not appear and the screen shows nothing. Then PC will go on non-key-component test. It keeps on even there is failure, with failure information showing on screen. When the computer works abnormally, especially key-component failure which not shown on screen, the advantage of using our PC Diagnostic Card is obvious. The failure will be found soon with POST code showing on PC Diagnostic Card.

3. Functional Characteristics

1. There is no need to install software. Combining advanced technology and user's behavioral science, QiGuan Electronics Co., Ltd humanized PC Diagnostic Card to be user-friendly. it is very easy to use. Thus it is not only applicable to the technicians, but also general PC users. It will make all new users professional masters.
2. Using large-scale IC integrated module with compact structure and stable performance, the high quality Diagnostics & Stability-Test Card can meet the high standards. With more internal resources, it has more excellent anti-jamming performance and lower rate of self failures.
3. Functional limitation of traditional PC Diagnostic Cards has been broken, e.g. we have created standard PCI interface and varieties of auxiliary parts that enhance the accuracy and reliability of PC Diagnostic Cards. And part of its functions depend on BIOS no more, and never limit to POST contents and manners.
4. Unlike traditional PC diagnostic cards that become useless when the system booted, KLPI6-SD helps you solve problems like system halt, blank screen, and instability, and keeps your computer running safely and stably.
5. Unprecedented compatibility. KLPI6-SD is compatible with all kinds of high, middle and low classes of motherboards in the market, and shows more accurate failure codes, there is even no exception for Intel 9XX series that represent the mainstream of top motherboards (such as SIS671) which can not be tested by the traditional PC diagnostic card.
6. The random initial codes which mislead the diagnoses are thoroughly eliminated. Kingnostic Card no more depends on RESET signal of the test computer, and can prevent impulse loss, correct failures automatically, even if the reset logic of the test computer is abnormal, it will not influence the testing functions of Kingnostics Cards and New Generation PC Diagnostic Card.
7. Adopting excellent control algorithm to page down the codes, which is easier

than the traditional diagnostic cards do, Kingnostic cards greatly lower the rate of inappropriate operation that lead to a low accuracy in test.

8. All the indicator lamps (such as CLK, IRDY and FRAME) are 100% correct. They will be ON only when there are signals and OFF when there are no signals, while the traditional ones will be ON once they have signals. Take the CLK indicator for example, it makes the users see clearly even single 10ns impulse. It will not be on when there is no CLK signal impulse, no matter the current signal stays at high or low level, which won't mislead the user. No pulse loss, and no useless pulse.
9. The Kingnostics Cards are even more advanced than the New Generation PC Diagnostic Cards. They extremely eliminated wrong codes, redundant codes, and won't miss any needed codes. The users can check all the failure codes by check switch. They are really the most accurate all around the world.
10. Eliminated the fault that test stops halfway, which makes test more efficient and reliable.
11. Supports 80h, 84h and 300h ports

4. Type Characteristics

1) Table of Type Characteristics

Type Series	Warning	PCI	ISA	LPT	MiniPCI	External Display	Remarks
PI2 or KPI2 Series	Optional	√	√	—	—	Optional	
KPI4/KPI6 Series	√	√	√	—	—	Optional	
P or KP Series	Optional	√	—	—	—	Optional	
KL Series	—	—	—	√	—	—	Parallel Port, by USB-Power
KLP Series	√	√	—	√	—	Optional	Parallel Port, by USB-Power
KM Series	—	—	—	—	√	Optional	
KLM Series	—	—	—	√	√	Optional	Parallel Port, by USB-Power

Descriptions:

- ① KL4 and KL6 are applicable to desktops and laptops with parallel port which support POST codes.
- ② KPI4 and KPI6 can be plugged in both PCI slot and ISA slot.
- ③ KM4 and KM6 can be plugged in MiniPCI slots of laptops.
- ④ KLM4 and KLM6 series can be plugged in MiniPCI slots of laptops and parallel ports of laptops and desktops.
- ⑤ KLP4 and KLP6 can be plugged in PCI ports and parallel ports of the desktops and laptops.

- ⑥ KLPI4 and KLPI6 can be plugged in PCI, ISA and LPT ports. Their test mode supports kinds of interfaces.
- 2) There are beep warning functions for KPI4, KPI6, KLP4 and KLP6.
- 3) KPI4 and KPI6 plugged incorrectly, no component will be burnt out.
- 4) By KPI4, KPI6, KM4 or KM6, the important signals of mainboard can be tested even without CPU, memory and video card.
- 5) KL4 and KL6 are USB-powered. Not plugged in the parallel port, KL4 or KL6 will not show codes no matter it is powered, which won't mislead the users.
- 6) External Display. You can see the failure codes from outside.

5. Operation Flow

1. Shut down the power and take out all extended cards. Plug the PC Diagnostic Card in ISA slot (Note: The front side of the component on ISA slot should face the power supply, otherwise neither PC Diagnostic Card nor the mainboard will work though they won't be burnt out), PCI slot, MiniPCI slot or parallel port (LPT). (Note: When using KL4, KL6, KLP4 or KLP6, plug the card into the parallel port first, then connect the USB line, finally start up the computer.)
2. The PC Diagnostic Card starts running and the LED shows the codes. The user may determine the testing result with POST Code Table (except extended equipments).
3. If the result shows failure, please shut down the power and solve the problem according to the POST Code Table. And repeat from step 2.
4. If the result shows normal, please shut down the power and plug in the video card, I/O card, keyboard, hard drives and extended cards, and restart up the computer.
5. The PC Diagnostic Card will start running again and the LED shows the codes. Determine the test result again with POST Code Table (It shows the working status of all hardware this time).
6. If the result shows failure, please shut down the power again and solve the problem according to the POST Code Table. And then repeat from step 2.
7. The test result shows normal, but the operating system can not boot, then the hitch may lie somewhere of software, disk drive, disk controller or DMA circuit. Please make relative treatment.

Flow Chart of PC Diagnostic Card Operation (lowest system for example)

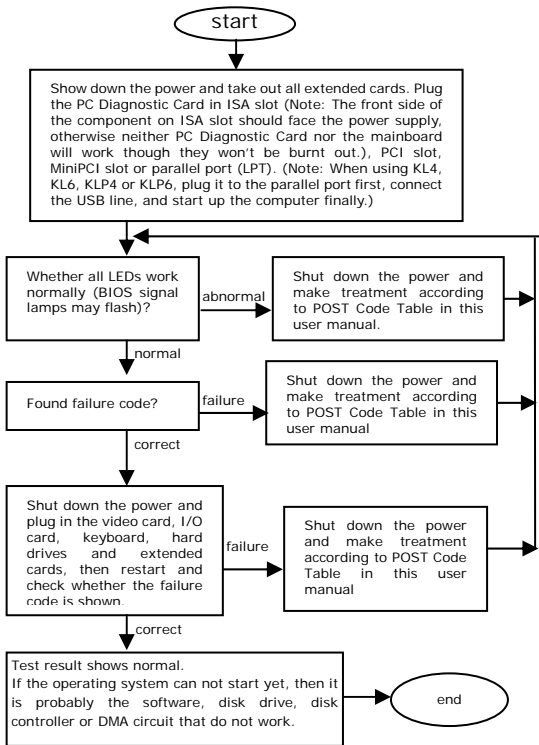

6. Must-Reads of Users

1. The same code of different brand motherboard BIOS means differently. So please make clear what is the version and type of the BIOS that you are going to

test. You may refer to the computer manual, check it from the CMOS chip on the mainboard or the screen when system is starting, or contact the BIOS supplier. The code meanings of this booklet are only for your reference.

2. The POST Code Table shows code values in ascending sequence, and coding order on the card is decided by BIOS. Please pay attention that the POST code values are usually continuous for common BIOS.

3. The mainboard pass the self test if the PC Diagnostic Card shows "FF" or "00" after a series of codes. The mainboard doesn't run if it stops and shows "no", "no-c" or "no-CPU" ("no" for short below). Is the CPU broken or is it correctly set? Is the power supply normal? Does the battery goes moldy? Refer to the 2nd clause of Chapter 10 for treatments when New Generation PC Diagnostic Cards and Kingnostics Cards show "no".

4. The PC Diagnostic Card shows normal when the mainboard which works wrong, probably the reason is that you have set no warning on CMOS, so the card will go on showing "00" or "FF" until it has found critical failure. Solution: Reset the CMOS and make it give warning for all failures, and then restart the computer. The PC Diagnostic Card will stop coding and show failure codes for all failures. The user can make relative treatment according to the failure codes.

5. For the four digit PC Diagnostic Cards such as KPI4, KLPI4, KL4 and KLP4, the kilobit and the hundreds on the LED show POST codes of the test computer, and the tens digit and the unit digit show the one that is before the failure code, as below:

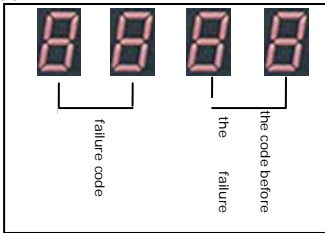

Figure 1: Four Digit POST Code Display

For example: If the LED shows D0, D1, D2, D3, D4, D5, D6, D7, D8, D9, DA, Db, DC and stops when testing a computer, the four digit card will show below as Figure 2, press the check switch once, it will go on to show as Figure 3.

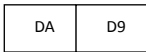
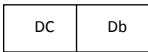

Figure 2: when the card stops running

Figure 3: after press the check switch once

Press the check switch again, it will show as Figure 4; Press for a third time, Figure 5, and it means there is no more codes to view.

DC	Db
----	----

no	-c
----	----

Figure 4: press the check switch once more

Figure 5: press the check switch thirdly.

Press the check switch fourthly, it goes back to failure codes as Figure 2.

6. For six Digit PC Diagnostic Cards such as KPI6, KLPI6, KL6 and KLP6, the codes show as below:

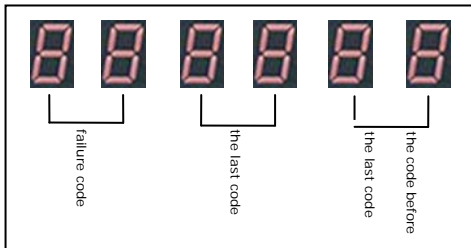

Figure A: Six Digit POST Code Display

For example: If the LED indicator shows D0, D1, D2, D3, D4, D5, D6, D7, D8, D9, DA, Db, DC and stops when testing a computer, the six-bit-code card will show as Figure B, press down the check switch once, it will go on to show as Figure C, but Figure B back after the switch rebounds.

DC	Db	DA
----	----	----

D9	D8	D7
----	----	----

Figure B: when the card stops running

Figure C: press down the check switch without rebound.

For another example: If the LED shows 15 codes such as C0, C1, C2, C3, C4, C5, C6, 31, 32, 33, 34, 35, 85, 86 and FF when testing the computer. You can see six codes shown as C5, C4, C3, C2, C1 and C0 if you press down the check switch when it begins to show C5. When restart the computer, you can see 35, 34, 33, 32, 31 and C6 if you press down the check switch when it begins to show 35. Restart the computer and wait until it shows "FF", you can see FF, 86, 85, 35, 34, 33 clear. So you will know all the POST codes no matter how many codes there are.

7. All Kingnostics Cards (including six digit, four digit and two digit) can test the redundant code and missing code phenomena of the traditional PC Diagnostic Cards. Plug a Kingnostics Card a traditional PC Diagnostic Card in the same mainboard, power on and compare their codes, and you will know the incorrect code of the traditional PC Diagnostic Card.

The code display of the two-digit Kingnostics Card is similar with that of the

four-digit Kingnostic Card. It shows a 2 digit code for each press. And it goes back to show "no" at the sixth press, and the last code that the test stopped at the seventh press. For example: If the LED shows D0, D1, D2, D3, D4, D5, D6, D7, D8, D9, Da, Db and stops at DC during testing, it will show Db for the first press, and Da the second press, ...D7 the fifth press, and "no" the sixth press. And it goes back to DC for the seven press, as below:

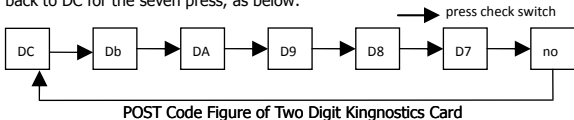

8. The KL4, KLP4, KL6 and KLP6 with parallel pots are applicable to the laptops and desktops with LPT. The failures can be found without opening the computer cases.

The USB line is used for power supply only. So the user have connect the parallel port with LPT, and then connect the USB of the PC Diagnostic Card and the USB of the computer with the USB line attached, finally turn on the PC and check the failure codes.

Note: Nowadays, most computers made in mainland and Taiwan use AMIBIOS and PHOENIXBIOS mainboard, and they can be tested with PC Diagnostic Cards that have parallel port. Other computers such as IBM, TOSHIBA, HP, DELL and SONY usually PHOENIXBIOS or IntelBIOS, the ones that use PHOENIXBIOS can be tested with PC diagnostic cards that have parallel port.

9. Time for the reset signals of ISA, PCI and LPT ports are different. Maybe PCI card still shows "no" when ISA card start to show POST codes. And time to show POST code for LPT port is also different with other interfaces such as PCI and ISA, and the parallel port and other interfaces show different codes when the PC works normally, because of different time sequence for PC managing different interfaces. But the failure codes shown are the same no matter what type of interface is used to in test.

10. The two digit and four digit PC Diagnostic Cards are not so mysterious as you imagine. What they can do is just to display the POST codes that indicate the failures (especially when the screen is blank). Some POST programs of BIOS stop at the last code which the system fails to pass (failure code), while the others stop at the last code which the system succeeds to pass (non failure code). With code recheck functions, KPI4, KM4A, KL4 and KLP4 can show what codes the self test has passed, from which the user can know what components work well. Both functions and performances of two digit and four digit PC diagnostic card are not better than those of KPI6, KM6, KL6 and KLP6. Because there is a wide range of code collection, many versions and types of BIOS, varieties of content of POST programs, new functions of BIOS, the meanings of codes may be not complete and perfect. So the code meanings in this manual are only for your reference. Please contact the mainboard manufacturers and BIOS makers for the most accurate and latest POST code information.

7. Hexadecimal Characters and Particular Characters of Our Cards

decimal	0	1	2	3	4	5	6	7	8	9	10	11	12	13	14	15	n	o	-	C	P	U
hexadecimal	0	1	2	3	4	5	6	7	8	9	A	B	C	D	E	F						
display on diagnostic cards	0	1	2	3	4	5	6	7	8	9	A	B	C	D	E	F	n	o	-	C	P	U

8. Meanings of POST codes

AMI

(00) Going to give control to INT 19H boot loader.

(10) Processor register test about to start, and NMI to be disabled, 286 reg. test about to start.

(02) NMI is disabled. Power on delay starting. Power on delay starting. 286 reg.

(03) Power on delay complete. To check soft reset/power-on. Any initialization before keyboard BAT is in progress. ROM BIOS checksum (32K at F800:0) passed.

(04) Any initialization before keyboard BAT is complete. Reading keyboard SYS bit, to check soft reset/power-on. Reading keyboard SYS bit, to check soft reset/power on. Keyboard controller test with and without mouse passed. 8259 initialization OK.

(05) Soft reset/power-on determined. Going to enable ROM. i.e. disable shadow RAM/Cache if any. Going to enable ROM, i.e. disable shadow RAM/cache if any. Chipset initialization over, DMA and interrupt controller disabled. CMOS pending interrupt disabled.

(06) ROM is enabled. Calculating ROM BIOS checksum, and waiting for keyboard controller input buffer to be free. Calculating ROM BIOS checksum. Video disabled and system timer begin. Video disabled and system timer counting OK.

(07) ROM BIOS checksum passed. CMOS shutdown register test to be done next. ROM BIOS checksum passed, Keyboard controller I/B free. Going to issue the BAT command to keyboard controller. Going to issue the BAT command to keyboard controller. CH-2 of 8254 initialization half way. CH-2 of 8253 test OK.

(08) CMOS shutdown register test done. CMOS checksum calculation to be done next. BAT command to keyboard controller is issued. Going to verify the BAT command. Going to verify the BAT command. CH-2 of timer initialization over. CH-2 delta count test OK.

(09) CMOS checksum calculation is done, CMOS diag byte written. CMOS initialize to begin. Keyboard controller BAT result verified. Keyboard command byte to be written next. (09) Keyboard command byte to be written next. CH -1 of timer initialization over. CH-1 delta count test OK.

(0A) CMOS initialization done (if any). Keyboard command byte code is issued. Going to write command byte data. Going to write command byte data. CH -0 of timer initialization over. CH-0 delta count test OK.

- (0B) CMOS status register initialize done. Keyboard controller command byte is written. Going to issue Pin -23, 24 blocking/ unblocking command. Going to issue pin -23, 24 blocking/ unblocking command. Refresh started. Parity status cleared.
- (0C) KB controller I/B free. Going to issue the BAT command to keyboard controller. Pin-3,24 of keyboard controller is blocked/unblocked. NOP command of keyboard controller to be issued next. NOP command of keyboard controller to be issued next. System timer started. Refresh & system timer OK.
- (0D) BAT command to keyboard controller is issued. Going to verify the BAT command. NOP command processing is done. CMOS shutdown register test to be done next. CMOS shutdown register test to be done next. Refresh link toggling passed. Refresh link toggling passed.
- (0E) Keyboard controller BAT result verified. Any initialization after KB controller BAT to be next. CMOS shut down register R/W test passed. Going to calculate CMOS checksum, and update DIAG. Going to calculate CMOS checks um, and update DIAG Byte. Refresh period ON/OFF 50% OK.
- (0F) initialization after KB controller BAT done. Keyboard command byte to be written next. CMOS checksum calculation is done, DIAG byte written. CMOS Init. To begin (If "INIT C MOS IN EVERY BOOT IS SET"). CMOS initialization to begin (If "INIT CMOS IN E VERY BOOT IS SET").
- (10) KB controller command byte is written. Going to issue p in-23,24 blocking/unblocking command. CMOS initialization done(if any). CMOS status register about to Init for Date and Time. CMOS status register about to Init for Date and Time. Refresh on and about to start 64K base memory test. Confirmed refresh ON & about to start 64 K memory.
- (11) Pin23,24 of keyboard controller is blocked/unblocked. Going to check to check pressing of <INS>key during power-on. CMOS status register initialized. Going to disable DMA and Interrupt controllers. Going to disable DMA and interrupt controllers. Address line test passed. Address line test passed.
- (12) Checking for pressing of <INS> key during power-on done. Going to disable DMA and Interrupt controllers. D MA controller#1,#2,interrupt controller#1,#2 disabled. About to disable Video display and Init port -B. About to disable video display and Init port -B.64K base memory test passed. 64K base memory test passed.
- (13) DMA controller#1,#2 ,interrupt controller#1,#2disa- bled. About to disable Video display and initialize port -B. Chipset initialize/auto memory detection about to begin. Replace first memory SIMM.(13)Chipset initialize/auto memory detection about to begin. Check first SIMM.(13) Interrupt vectors initialized.
- (14) Chipset initialization/auto memory detection over. To uncompress the POST code if compressed BIOS. 8254 timer test about to start. 8254 timer test about to start.8042 keyboard controller test OK.
- (15) POST code is un -compressed.8254 timer about to start. CH-2 timer test halfway. 8254 CH-2 timer test to be completed. 8254 CH-2 timer test to be completed. Interrupt vectors initialized. CMOS read/write test OK.
- (16) CH-2 timer test over.8254 CH-1 timer test to be completed. CMOS checksum/battery check OK.
- (17) CH-1 timer test over. 8254 CH-0 timer test to be completed. Monochrome

mode set.

(18) CH-0 timer test over. About to start memory refresh. Color mode set.

(19) 82 timer test over. Memory refresh test to be done next. About to look for optional video ROM at segment C000 and give control to the optional video ROM if present.

(1A) Memory refresh line is toggling. Going to check 15 micro second ON/OFF time. Return from optional video ROM. Optional video ROM control OK

(1B) Memory refresh period 30 micro second test complete. Base 64K memory test about to start. Shadow RAM enable /disable completed. Display memory read/write test OK.

(1C) Display memory read/write test for main display type as set in the CMOS setup program over. Display memory read/write test for alternate display OK.

(1D) Display memory read/write test for alternate display type complete if main display memory read/write test returns error. Video retrace check OK. Set configuration from CMOS.

(1E) Global equipment byte set for proper display type.

(1F) Video mode set call for mono/color be gins. Mode set call for mono/color OK. Set EISA mode; If EISA non-volatile memory checksum is good, execute EISA initialization. If not, execute ISA test and clear EISA mode flag. Test EISA configuration memory integrity (checksum & communication interface).

(20) Memory refresh period 30 micro second test complete. Base 64K memory/address test started. Address line test to be done next. Video mode set completed.

(21) Address line test passed. Going to do toggle parity. ROM type 27256 verified. Video display OK.

(22) Toggle parity over. Going for sequential data R/W test on 64 K memory. Power on message display OK.

(23) Base 64K sequential data R/W test passed. Going to SET BIOS stack and to do any setup before Interrupt vector Init. Any setup before interrupt vector Init about to start. Power on message displayed.

(24) Setup required before vector initialization complete. Interrupt vector initialization about to begin.

(25) Interrupt vector initialization done. Going to read Input port of 9042 for turbo switch(if any). Going to read I/O port of 8042 for turbo switch(if any).

(26) I/O port of 8042 is read. Going to initialize global data for turbo switch. Going to initialize global data for turbo switch.

(27) Global data initialization for turbo switch is over. Any initialization before setting video mode to be done next.

(28) Initialization before setting video mode is complete. Going for monochrome mode and color setting. Check extended memory.

(29) Monochrome mode setting is done. Going for color mode setting.

(2A) Monochrome Color mode setting is done. About to go for toggle parity before optional ROM test. About to go for toggle parity before optional ROM Check.

(2B) Toggle parity over. About to give control for any setup required before optional video ROM check.

(2C) Processing before video ROM control is done. About to look for optional video

ROM and give control.

(2D) Optional video ROM control is done. About to give control to do any processing after video ROM returns control.

(2E) Return from processing after the video ROM control. If EGA/VGA not found then do display memory R/W test.

(2F) EGA/VGA not found. Display memory R/W test about to begin.

(30) Display memory R/W test passed. About to look for the retrace checking. Virtual mode memory test about to begin.

(31) Display memory R/W test or retrace checking failed. About to do alternate Display memory R/W test. Virtual mode memory test started.

(32) Alternate display memory R/W test passed. About to look for the alternate display retrace checking. Processor executing in virtual mode.

(33) Video display checking over. Verification of display type with switch setting and actual card to begin. Verification of display type with switch setting and Actual Card to begin. Memory address line test in progress.

(34) Verification of display adapter done. Display mode to be set next. Memory address line test in progress.

(35) Display mode set complete. BIOS ROM data area about to be checked. Memory below 1MB calculated.

(36) BIOS ROM data area check over. Going to set cursor for power on message. Memory above 1MB calculated.

(37) Cursor setting for power on message id complete. Going to display the power on message. Memory test about to start.

(38) Power on message display complete. Going to read new cursor position. Memory below 1MB initialized.

(39) New cursor position read and saved. Going to display the Hit< DEL> message. Memory above 1MB initialized.

(3A) Check memory, first 64K, one long beep. Reference string display is over. Going to display the Hit<ESC> message. Memory size display initiated. This will be updated when the BIOS goes through the memory. Award (3A) Check memory.

(3B) Hit or <ESC> message displayed. Virtual mode memory test about to start, About to start below 1MB memory test.

(3C) Memory test below 1MB completed and about to start above 1MB test. Award (3C) Set flag to allow users to enter CMOS setup utility. Setup enabled.

Phoenix (3C) Configure advanced chipset registers. (Beep)=1 -4-4-1. Determine relative CPU speed.

(3D) Memory test above 1MB completed.

(3E) About to go to real mode (shutdown).

(3F) Shutdown successful and Processor in real mode.

(40) Preparation for virtual mode test started. Going to verify from video memory. CACHE memory on and about to disable A20 address line.

(41) Returned after verifying from display memory. Going to prepare the descriptor babbles. A20 address line disabled successful.

(42) Descriptor tables prepared. Going to enter in virtual mode for memory test. 486 internal cache turned on. About to start DMA controller test.

(43) Entered in the virtual mode. Going to enable interrupts for diagnostics mode.

About to start DMA controller test.

(44) Interrupts enabled(if post switch is on). Going to initialize data to check memory wrap around at 0:0.

(45) Data initialized. Going to check for memory wrap around at 0:0 and the total system memory size.

(46) Memory wrap around test done. Memory size calculation over, writing patterns to test memory.

(47)Pattern to be tested written in extended memory, 640 K memory.

(48)Patterns written in base memory. Going to find out amount of memory below 1M memory.

(49)Memory below 1M found and verified. Going to find out amount of memory above 1M memory.

(4A)Amount of memory above 1M found and verified. Going for BIOS ROM data area check.

(4B) Amount of memory above 1M found and verified. Check for soft reset and going to clear memory below 1M for reset (If power on, go to check point#4Eh). BIOS ROM data area check over. Going to check <ESC> and to clear memory below 1M for soft reset.

(4C) Memory below 1M cleared. (SOFT RESET) Going to clear memory above 1M.

(4D) Memory above 1M cleared. (SOFT RESET)Going to save the memory size. (GOTO check point#52h).

(4E) Memory test started. (NO SOFT RESET) About to display the first 64K memory test.

(4F) Memory size display started. This will be updated during memory test. Going for sequential and random memory test. Processor in real mode after shutdown.

(50) Memory testing/initialization below 1M complete. Going to adjust displayed memory size for relocation /shadow. DMA page register test complete.

(51) Memory size display adjusted due to relocation /shadow. Memory test above 1M to follow. DMA unit -1 base register test about to start.

(52) Memory testing/initialization below 1M complete. Going to save memory size information. Going to prepare to go back to real mode. DMA unit-1 channel OK, about to begin CH-2.

(53) Memory size information is saved. CPU registers are saved. Going to enter in real mode. DMA CH-2 base register test OK.

(54) Shutdown successful, CPU in real mode. Going to restore registers saved during preparation for shut down. About to check F/F latch for unit-1 and unit-2.

(55) Registers restored. Going to disable gate A20 address line. F/F latch for both units checked.

(56) A20 address line disable successful. BIOS ROM data area about to be checked. DMA unit 1 and 2 programming over and about to initialize 8259 interrupt controller.

(57) A20 address line disable successful. BIOS ROM data area check halfway. BIOS ROM data area check to be complete.8259 initialization over.

(58) Memory size adjusted for relocation/shadow. Going to clear Hit message. BIOS ROM data area check over. Going to clear Hit<ESC > message. 8259 mask register check OK.

- (59) Hit<ESC> message cleared. <Wait..> message displayed. About to start DMA and interrupt controller test. Master 8259 mask register OK, about to start slave.
- (5A) About to check timer and keyboard interrupt level.
- (5B) Timer interrupt OK.
- (5C) About to test keyboard interrupt.
- (5D) ERROR! Timer/keyboard interrupt not in proper level.
- (5E) 8259 interrupt controller error.
- (5F) 8259 interrupt controller test OK.
- (60) DMA page register test passed. About to go for DMA #1, verify from display memory.
- (61) Display memory verification over. About to go for DMA #1 base register test.
- (62) DMA#1 base register test passed. About to go for DMA #2 base register test.
- (63) DMA #2 base register test passed. About to go for BIOS ROM data area check.
- (64) BIOS ROM data area check halfway. BIOS ROM data area check to be completed.
- (65) DMA #2 base register test passed. About to program DMA unit 1 and 2.
- (66) DMA unit 1 and 2 programming over. About to initialize 8259 interrupt controller.
- (67) 8259 initialization over. About To start keyboard test.
- (70) Start of keyboard test.
- (71) Keyboard controller BAT test over.
- (72) Keyboard interface test over, mouse interface test started.
- (73) Global data initialization for keyboard/mouse over.
- (74) Display 'SETUP' prompt and about to start floppy setup.
- (75) Floppy setup over.
- (76) Hard disk setup about to start.
- (77) Hard disk setup over.
- (79) About to initialize timer data area.
- (7A) Timer data initialized and about to verify CMOS battery power.
- (7B) CMOS battery verification over.
- (7D) About to analyze POST results. About to analyze diagnostic test results for memory.
- (7E) CMOS memory size updated.
- (7F) Look for key and get into CMOS setup if found. About to check optional ROM C000:0.
- (80) Keyboard test started, clearing output buffer, checking for stuck key, About to issue keyboard reset command. About to give control to optional ROM in segment C800 to DE00.
- (81) Keyboard reset error/stuck key found. About to issue keyboard controller interface test command. Optional ROM control over.
- (82) Keyboard controller interface test over. About to write command byte and Init circular buffer. Check for printer ports and put the addresses in global data area.
- (83) Command byte written, global data Init done. About to check for lock -key. Check for RS232 ports and put the addresses in global data area.

- (83) Command byte written, global data Init done. About to check for lock -key. Check for RS232 ports and put the addresses in global data area.
- (84) Lock-key checking over. About to check for memory size mismatch with CMOS. Co-Processor detection over. 80287 check/test OK.
- (85) Memory size check done. About to display soft error and check for password or bypass setup. About to display soft error message. If no video replace Video card.
- (86) Password checked. About to do programming before setup. About to give control to system ROM at segment E000.
- (87) Programming before setup complete. Going to uncompress SETUP code and execute CMOS setup. System ROM E000:0 check over.
- (88) Returned from CMOS setup program and screen is cleared. About to do programming after setup.
- (89) Programming after setup complete. Going to display power on screen message.
- (8A) First screen message displayed. About to display <WAIT...>message.
- (8B) First screen message displayed <WAIT...> message displayed. About to do Main and Video BIOS shadow.
- (8C) Main and video BIOS shadow successful. Setup options programming after CMOS setup about to start.
- (8D) Setup options are programmed, mouse check and Init to be done next. Going for hard disk, floppy reset.
- (8E) Mouse check and initialization complete. Going for hard disk controller reset. About to go For floppy check.
- (8F) Hard disk controller reset done. Floppy setup to be done next.
- (90) Floppy setup is over. Test for hard disk presence to be done.
- (91) Floppy setup complete. Hard disk setup to be done next.
- (92) Hard disk setup complete. About to go for BIOS ROM data area check.
- (93) BIOS ROM data area check halfway. BIOS ROM data area check to be completed.
- (94) Hard disk setup complete. Going to set base and extended memory size. BIOS ROM data area check over.
- (95) Memory size adjusted due to mouse support, hard disk type-47. Going to verify from display memory.
- (96) Memory size adjusted due to mouse support, hard disk type -47.Going to do any Init before C800 optical ROM control. Returned after verifying from display memory.
- (97) Any Init before C800 optional ROM control is over. Optional ROM check & control will be done next.
- (98) Optional ROM control is done. About to give control to do any required processing after optional ROM returns control.
- (99) Any initialization required after optional ROM test over. Going to setup timer data area and printer base address .
- (9A) Return after setting timer and printer base address. Going to set the RS -232 base address.
- (9B) Returned after RS-232 base address. Going to do any initialization before

Co-Processor test.

(9C) Required initialization before Co-Processor is over. Going to initialize the Co-Processor next.

(9D) Co-Processor initialized. Going to do any initialization after Co-Processor test.

(9E) Initialization after Co-Processor test is completed. Going to check expander keyboard, keyboard ID and number-lock.

(9F) Extended keyboard check is done, ID flag set. Number-lock on/off. Keyboard ID command to be issued.

(A0) Keyboard ID command issued. Keyboard ID flag to be reset. Compaq (A0) Start of diskette tests.

(A1) Keyboard ID flag reset . Cache memory test to follow.

(A2) Cache memory test over. Going to display any soft errors.

(A3) Soft error display complete. Going to set the keyboard type matrix rate.

(A4) Keyboard type matrix rate set. Going to program memory wait states.

(A5) Memory wait states programming over. Going to clear the screen and enable parity/NMI.

(A6) Screen cleared. Going to enable parity and NMI.

(A7) NMI and parity enabled. Going to do any Initialization required before giving control to optional ROM at E000.

(A8) Initialization before E0 00 ROM control over. E000 ROM to get control next.

(A9) Returned from E000 ROM control. Going to do any init required after E000 optional ROM control.

(AA) Initialization after E000 optional ROM control is over. Going to display the system configuration.

(B0) System configuration is displayed. Going to un-com-press SETUP code for hot-key setup.

(B1) Un-compressing of SETUP code is complete. Going to copy any code to specific area.

(C2) NMI is Disable. Power on delay start on.

(C3) Check memory(Cache, Video or first 64 K).

(C5)Power on delay complete. Going to enable ROM i.c. disable Cache if any.

(C6) Calculating ROM BIOS checksum.

(C7) ROM BIOS checksum passed. CMOS shutdown register test to be done next.

(C8)CMOS Shut down register test done. CMOS checksum calculation to be done next.

(CA) CMOS checksum calculation is done, CMOS Drag byte written. CMOS status register about to initializing for Date and Time.

(CB)CMOS status register Init done. Any initialization before keyboard BAT to be done next.

(CD) BAT command to keyboard controller is to be issued.

(CE) Keyboard controller BAT result verified. Any initialization after KB controller.

(CF) Initialization after KB controller BAT done. Keyboard command byte to be written next.

(D1) Keyboard controller command byte is written. Going to check pressing of <INS> key during power-on.

(D2) Checking for pressing of <INS>key during power-on done. Going to disable

DMA and Interrupt controllers.

(D3) DMA controller #1,# 2,interrupt controller #1,#2 disable. Video display is disable and port-B is initialized. Chipset initialize/auto memory detection about to begin.

(D4) Chipset Initialization/auto memory detection about to begin. Check SIMM for mismatch.

(D5) RUNT IME code is un-compressed.

(DD) Transfer control to uncompressed code in shadow ram at F000:FFF0.

AWARD

(01) Processor test 1;Processor status(1FLAGS) verification; Tests the following processor status flags carry, zero, sign, overflow. The BIOS will set each of these flags, verify they are set then turn each flag off and verify it is off.

(02) Processor test 2; Read/write/verify all CPU registers except SS, SP and BP with data pattern FF&00. Determine status of manufacturing jumper.

(03) Initialize Chips; Disable NMI, PIE, AIE, UEI, SQWV, disable video, parity checking, DMA; Reset math Coprocessor; Clear all page registers, CMOS shutdown byte; Initialize timer 0, 1 and 2 including set EISA timer to a known state; Initialize DMA controllers 0 and 1; Initialize interrupt controller 0 and 1; Initialize EISA extended registers. Calculate BIOS EPROM and sign -on message checksum; fail if not 0. Initialize EISA registers (EISA) BIOS only. Clear 8042 keyboard controller.

(04) Test memory refresh toggle; RAM must be periodically refreshed in order to keep the memory from decaying. This function assures that the memory refresh function is working properly. Test CMOS RAM I/O port interface and verify battery power is available (bat. status=1). Reset 8042.

(05) Keyboard controller self-test enable keyboard inter face. Blank video, Initialize keyboard; Keyboard controller initialization. Initialize Chips; Disable NMI, PIE, AIE, UEI, SQWV, disable video, parity checking, DMA; Reset math Coprocessor; Clear all page registers, CMOS shutdown byte; Initialize timer 0, 1 and 2 including set EISA timer to a known state; Initialize DMA controllers 0 and 1; Initialize interrupt controller 0 and 1; Initialize EISA extended Registers. Get manufacturing status, reset if set(loop 1 -5).

(06) Test memory refresh toggle; RAM must be periodically refreshed in order to keep the memory from decaying. This function assures that the memory refresh function is working properly. Initialize chips.

(07) Verifies CMOS's basis R/W functionality. Test CMOS interface and battery status; Verifies CMOS is working correctly, detects bad battery. Setup low memory; Early chip set initialization; Memory presence test; OEM chip set routines; Clear low 64K of memory; Test first 64 K memory; clear lower 256K of memory, enable parity checking and test parity in lower 256K; test lower 25 If the BIOS detects error 2C, 2E, or 30 (base 512K RAM error), it displays 6K memory. Set up stack, beep. Read/write/verify CPU registers.

(08) Setup low memory; Early chip set initialization; Memory presence test; OEM chip set routines; Clear low 64K of memory; Test first 64K memory; clear lower 256K of memory, enable parity checking and test parity in lower 256K; test lower 256K memory. Set up stack, beep. Setup interrupt vector table in lower 1K RAM

area; Initialize first 120 interrupt vectors with SPURIOUS_INT_HDLR and initialize INT 00h-1Fh according to INT_TBL. Initialize CMOS timer.

(09) Program the configuration register of Cyrix CPU. OEM specific cache initialization. Early Cache initialization; Cyrix CPU initialization; cache initialization. Test CMOS RAM checksum; beep; also test extended storage of parameters in the motherboard chipset; if not warm-booting; display the Test CMOS RAM checksum message, if bad, or insert key pressed, load defaults if bad. Check BIOS Checksum.

(0A) Initialize the first 32 interrupt vectors. Initialize INTs 33 to 120. Early Power Management initialization. Setup interrupt vector table in lower 1 K RAM area; Initialize first 120 interrupt vectors with SPURIOUS_INT_HDLR and initialize INT 00h-1Fh according to INT_TBL. Initialize key - board; Detect type of keyboard controller (optional 8242 or 8248, with Nedadon XOR gate control); Set NUM_LOCK status. Reset keyboard test keyboard controller interface to verify it returned AAH and responded to enable/disable commands, set keyboard buffer, enable keyboard and keyboard interrupts for normal use, beep, halt. Initialize Video controller.

(0B) Verify the RTC time is valid or not. Detect bad battery. Read CMOS data into BIOS stack area. Perform PnP initializations. Assign I/O & Memory for PCI devices (PCI BIOS Only). Test CMOS RAM checksum; beep; also test extended storage of parameters in the motherboard chipset; if not warm-booting, display the Test CMOS RAM checksum message, if bad, or insert key pressed, load defaults if bad. Initialize video interface; Detect CPU clock; Read CMOS location 14b to find out type of video in use; Detect and initialize video adapter. 8254 timer, channel 0 test.

(0C) Initialization of the BIOS data area(40:00 -40:FF). Initialize keyboard; Detect type of keyboard controller (optional 8242 or 8248, with Nedadon XOR gate control); Set NUM_LOCK status. Reset keyboard test keyboard controller interface to verify it returned AAH and responded to enable/disable commands, set keyboard buffer, enable keyboard and keyboard interrupts for normal use, beep, halt. 8254 timer, channel 1 test.

(0D) Program some of the chipset's value. Measure CPU speed for display. Video initialization including MDA, CGA, EGA/VGA. Initialize video interface; Detect CPU clock; Read CMOS location 14b to find out type of video in use; Detect and initialize video adapter. OEM specific -Initialize motherboard special chipset as required by OEM; initialize cache controller early, when cache is separate from chipset. 8254 timer, channel 2 test.

(0E) Initialize the APIC (Multi-Processor BIOS only). Test video RAM (If Monochrome display device found). Show startup screen message. Test video memory; Test video memory, write sign-on message to screen. Setup shadow RAM - Enable shadow according to setup. Test COMS Shut down byte.

(0F) DMA channel 0 Test. Test DMA controller 0; BIOS checksum test, keyboard detect and initialization. Test Extended CMOS.

(10) DMA channel 1 Test. Test DMA controller 1 with AA, 55, FF, 00 pattern. 8237 DMA, channel 0 test.

(11) DMA page register test. Test DMA page registers, use I/O ports to test address circuits. POST enables user reboot here. Test DMA page registers. FATAL

DISP LAY ERRORS. 8237 DMA, channel 1 test.

(12) Call support 800 -909-3424. Test 8254 timer 0 channel 0. Test DMA page registers.

(13) Test 8254 timer 0 channel 1. Test keyboard controller.

(14) Test 8254 timer 0 counter 2. Test timer counter 2; Test 8254 timer 0 counter 2. Test memory refresh.

(15) Test 8259 interrupt mask bits for channel 1. Test 8259-1 mask bits; Verify 8259 channel 1 masked interrupt by alternate turning off and on the interrupt line. Test 1st 64K of system memory.

(16) Test 8259-2 mask bits; Verify 8259 channel 2 masked interrupt by alternate turning off and on the interrupt line. Setup Interrupt vectors.

(17) Test stuck 8259's interrupt bits; Turn off interrupt then verify no interrupt mask register is on. Setup video I/O operations.

(18) Test 8259 interrupt functionality; Force an interrupt and verify the interrupt occurred. Test video memory.

(19) Test 8259 functionality. Test stuck NON-Maskable Interrupt bits(Parity/I/O check);Verify NMI can be cleared. 8259 Interrupt controller, channel 1 mask bits test.

(1A) Display CPU clock.8259 Interrupt controller, channel 2 mask bits test.

(1B) Test CMOS battery status. Test the system ROM.

(1C)Test CMOS RAM checks um. Test CMOS.

(1E) If EISA NVM checksum is good, execute EISA initialization(EISA BIOS ONLY). Size system memory.

(1F)Test system memory.

(20) Enable slot 0; Initialize slot 0(system board). (Check memory size). 8259 stuck bits test.

(21) Enable slots 1 through 15; Initialize slot 1.Test stuck NMI bits (parity I/O check).

(22) Enable slots 2; Initialize slot 2. Test 8259 working.

(23) Enable slots 3;Initialize slot 3. Test protected mode.

(24) Enable slots 4; Initialize slot 4.Size extended memory.

(25) Enable slots 5; Initialize slot 5. Test extended memory.

(26) Enable slots 6; Initialize slot 6. Test protected mode exceptions.

(27) Enable slots 7; Initialize slot 7. Setup cache control or shadow RAM.

(28) Enable slots 8; Initialize slot 8. Setup 8242.

(29) Enable slots 9; Initialize slot 9.

(2A) Enable slots A; Initialize slot A. (2A)8242 initialization.

(2B) Enable slots B; Initialize slot B. Initialize floppy drive and controller.

(2C) Enable slots C; Initialize slot C. Detect & initialize serial ports.

(2D) Enable slots D; Initialize slot D. Detect & initialize parallel ports. Test timer 2.

(2E) Enable slots E; Initialize slot E. Initialize hard drive & controller.

(2F) Enable slots F; Initialize slot F. Detect & initialize 80x87 Coprocessor.

(30) Get base memory & extended memory size. Size base And extended memory from 256K to 640K and extended memory above 1MB.

(31) Test base and extended memory; Test base memory from 256K to 640K and extended memory above 1MB using various patterns. Detect & initialize optional

ROMs.

(32) Display the Award Plug & Play BIOS extension message(PnP BIOS only).Test EISA extended memory; If EISA mode flag is set then test EISA memory found in slots initialization, This test is skipped in ISA mode and can be skipped with ESC key in EISA mode.

(33) Call Tech Support 727 -532-4151.

(36) Warm Start shut down.

(38) shadow system BIOS ROM.

(3A) Auto size cache.

(3C) Advanced configuration of chipset registers.

(3D) Initialize keyboard. Install PS/2 mouse. Initialize & install mouse; Detect if mouse is present, initialize mouse, install interrupt vectors.

(3E)Try to turn on level 2 cache.

(3F) Enable shadow RAM per CMOS RAM setup or if MEMORY TYPE is SYS in the EISA configuration.

(40) Display virus protect disable or enable.

(41) Initialize floppy disk drive controller.

(42) Initialize hard drive & controller; Initialize hard drive controller and any drives.

(43) If it is a PnP BIOS, initialize serial & parallel ports. Detect & initialize serial/parallel ports; Initialize any serial and parallel ports (also game port).

(44) Going to initialize data to check memory re-map at 0:0.

(45) Detect & Initialize math Coprocessor; Initialize math Coprocessor.

(46) Display the setup message(to press Ctrl -Alt-Esc to enter setup), and enable setup.

(47) Set system speed for boot.

(48) Check video configuration against CMOS.

(49) Initialize PCI bus and devices.

(4A) Initialize all video adapters in system.

(4B) QuietBoot start (optional).

(4C) Shadow video BIOS ROM.

(4E) If there is any error, show all the error messages on the screen & wait for user to press<F1>. Manufacturing POST loop or display messages; Reboot if manufacturing POST loop pin is set. Otherwise display any messages and enter setup.

(4F) If password is needed, ask for password. Clear the Energy Star logo (Green BIOS only). Security check; Ask password security.

(50) Write all the CMOS values currently in the BIOS stack areas back into the CMOS. Write CMOS; Write all CMOS values back to RAM and clear screen.

(51) Pre-boot enable; Enable parity checker; Enable NMI, Enable cache before boot.

(52) Initialize all ISA ROMs. Later PCI initializations(PCI BIOS only). PnP initializations(PnP BIOS only). Program shadow RAM according to setup settings. Program parity according to setup setting. Power Management initialization. Initialize option ROMs; initialize any option ROMs present from C8000h to EFFFh.

(53) If it is not a PnP BIOS, initialize serial & parallel ports. Initialize time value in

- BIOS data area. Initialize time value; Initialize time value in 40h BIOS data area.
- (55) Check PCI video Card -or replace video card.
- (60) Setup virus protection(Boot sector protection).
- (61) Try to turn on level 2 cache. Set the boot up speed according to setup setting. Last chance for chipset initialization. Last chance for power management initialization. Show the system configuration table.
- (62) Setup daylight saving according to setup values. Program the NUM lock, type rate & type speed according to setup setting. Setup NUM_LOCK; Setup NUM_LOCK status according to setup.
- (63) If there is any changes in the hardware configuration, update the ESCD information n(PnP BIOS only. Clear memory that have been used. Boot system via INT 19h.
- (B0) Spurious interrupt occurred in protect mode. Check mismatch memory.
- (B1) If unmasked NMI occurs, Press F1 to disable NMI,F2 to boot.
- (BE) Program defaults values into chipset.(BE)Chipset default initialization; Program chipset registers with power on BIOS defaults.
- (BF) Program the rest of the chipset (BF)Chipset initialization; Program chipset registers with setup values.
- (C0) Turn off chipset cache; OEM Specific -cache control.
- (C1) Memory presence test; OEM specific-test to size on - board memory. Bad SIMM.
- (C3) DRAM Select page, Check BIOS setting and first SIMM, Possible address line failure.
- (C4) CMOS conflicts, check video switch, BIOS(Chipset) on the video not initializing.
- (C5) Early shadow; OEM Specific -Early shadow enable for fast boot.
- (C6) Cache presence test; External cache size detection. (Check Memory first 64K.Check CPU jumper Setting). Also, Check Video memory
- (C7) Shadow video/system BIOS after memory pass.
- (C8) CMOS Shutdown, time delay.
- (CA) Micronics cache initialization.
- (CC) NMI handler shutdown.
- (FF)System booting. This means that the BIOS already passed control to the operation system. If no error flags such as memory size are set ,boot via INT 19 -load system from drive A, then C; display error message if correct boot device not found.
- Boot system.
- (EE)Unexpected Processor exception.

Phoenix

- (01) [Beep]=none 80286 register test in progress.
- (02) Verify real -mode operation(Beep)=1 -1-1-3.CPU Flags test.
- (02) [Beep]=1-1-3 CMOS write/read test in -progress or failure.
- (03) Disable Non-Maskable Interrupt(NMI).[Beep]=1 -1-4 BIOS ROM checksum in-progress or failure.

- (04) Get the CPU type (Beep)=1 -1-2-1.CPU register test. Programmable Interval Timer test failure.
- (05) [Beep]=1-2-2 DMA initialization in-progress or failure.
- (06) Initialize system hardware (Beep)=1 -1-2-3.DMA page register write/read test in-progress or fail.
- (08) Initialize chipset registers with POST values. [Beep]= 1 -3-1 RAM refresh verification in -progress or failure.
- (09) Set POST flay.(Beep)=1-1-3-2. 1st 64K RAM test in-progress.
- (0A) Initialize CPU registers. (Beep)=1 -1-3-3. Perform BIOS checksum test. 1st 64K RAM chip or data line failure multi -bit.
- (0B)Enable CPU Cable -Check CPU Jumpers. [Beep]=1 -3-4 1st 64K RAM odd/even logic failure.
- (0C) Initialize cache to initial POST value. Test DMA page registers. [Beep]=1 -4-1 1st 64K RAM address line failure.
- (0D) [Beep]=1-4-2 1st 64K RAM parity test in progress or failure.
- (0E) Initialize I/O.(Beep)=1 -1-4-3. Test 8254 timers.
- (0F) Initialize the local IDE
- 10) Initialize Power Management.(Beep)=1 -2-1-1.Initialize 8254 timers.[Beep]=2 -1-1 1st 64K RAM chip or data line failure-bit 0.
- (11) Load alternate registers with POST values.(Beep)=1 -2- 2. 1st 64K RAM chip or data line failure-bit 1.
- (12) Restore CPU control word during warm boot. J ump to User Path 0.(Beep)=1-2-1-3.Test both 8237 DMA controllers. 1st 64K RAM chip or data line failure-bit 2.
- (13)[Beep]=2 -1-4 1st 64K RAM chip or data line failure -bit 3. Initialize PCI Bus Mastering devices.
- (14) Initialize keyboard controller.(Beep)=1 -2-2-1.Initialize 823 7 DMA controllers.[Beep]=2 -2-1 1st 64K RAM chip or data line failure -bit 4.
- (15) [Beep]=2-2-2 1st 64K RAM chip or data line failure-bit 5.
- (16) BIOS ROM checksum .(Beep)=1 -2-2-3. Initialize 8259, reset Coprocessor.[Beep]=2 -2-3 1st 64K RAM chip or data line failure -bit 6.
- (17)Initialize cache before memory auto -size.[Beep] =2-2-4 1st 64K RAM chip or data line failure-bit 7.
- (18)8254 timer initialization.(Beep)=1 -2-3-1. Test 8259 interrupt controllers registers.[Beep]=2-3-1 1st 64K RAM chip or data line failure -bit 8.
- (19) check memory[Beep]=2-3-2 1st 64K RAM chip or data line failure -bit 9.
- (1A) 8237 DMA controller initialization.(Beep)=1 -2-3-3. Verify refresh is occurring.[Beep]=2 -3-3 1st 64K RAM chip or data line failure-bit A.
- (1B) [Beep]=2 -4-1 1st 64K RAM chip or data line failure - bit B.
- (1C) [Beep]=2 -4-1 1st 64K RAM chip or data line failure- bit C. Reset Programmable Interrupt Controller.(Beep)=1 -2 "C4-1.Base 64K address test.
- (1D) [Beep]=2-4-2 1st 64K RAM chip or data line failure - bit D
- (1E) [Beep]=2-4-3 1st 64K RAM chip or data line failure - bit E. Base 64K RAM test(16 b its).
- (1F) [Beep]=2-4-4 1st 64K RAM chip or data line failure - bi t F.
- (20) [Beep]=3-1-1 master DMA register test in -progress or failure. Test DRAM

refresh.(Beep)=1-3-1-1. Upper 16 of 32 bit test failed.

(21) [Beep]=3-1-2 slave DMA register test in -progress or failure.

(22) [Beep]=3-1-3 master interrupt mask register test in - progress or fail. Test 8742 keyboard controller.(Beep)=1 - 3-1-3

(23) [Beep]=3-1-4 slave interrupt mask register test in -progress or fail.

(24) Set ES segment to register to 4 GB.(beep)=1 -3-2-1. Verify CMOS/Configure CMOS.

(25) [Beep]=none interrupt vector loading in-progress.

(26) Enable A20 line. Verify/Load NVRAM parameters.

(27) [Beep]=3-2-4 keyboard controller test in -progress or failure.

(28) [Beep]=3-3-1 CMOS power-fail and checks um checks in -progress. Auto -size DRAM.(Beep)=1 -3-3-1.Protected mode 1.

(29) [Beep]=3-3-2 CMOS configuration info validation in - progress. Initialize POST Memory Manager.

(2A) Clear 512K base RAM.(Beep)=1 -3-3-3.Aubo-site memory chips.

(2B) [Beep]=3 -3-4 screen memory test in-progress or failure.

(2C)RAM failure on address xxxx. If the BIOS detects error 2C,2E,or 30(base 512K RAM error),it displays and additional word -bitmap (xxxx) indication the address line or bits that failed. For example, "2C 0002"means address line 1 (bit one set) has failed. "2E 1020 means data bits 12 and 5 (bits 12 and 5 set) have failed in the lower 16 bits. Note that error 30 cannot occur on 386SX systems because the y have a 16 rather than 32-bit bus. The BIOS also sends the bitmap to the port -80 LED display. It first display the check point code, followed b y a delay, the high -order byte, another delay, and then the low-order byte of the error. It repeats this sequence continuously.

Test 512 base address lines.(Beep)= 1-3-4-1 Activate interleave(if possible).[Beep]3-4-1 screen initialization in -progress or failure.

(2D) [Beep]=3-4-2 screen retrace tests in -progress or failure.

(2E) See Error code "2C". Test 512K base memory.(Beep)= 1-3-4-3.Exit 1st protected mode test.[Beep]=none search for video ROM in -progress.

(2F) Enable cache before system BIOS shadow.

(30) see Error Code "2C".Unexpected shutdown.[Beep]=no - ne screen believed operable. [Beep]=none screen believed running w/video ROM.

(31) [Beep]=none monochromatic screen believed operable.

(32)Test CPU bus-clock frequency.(Beep)=1-4-1-3.Deter- mine system board memory size. [Beep]=none 40-column color screen believed operable.

(33) [Beep]=none 80 -column color screen believed operable. Initialize dispatch Manager.

(34) [Beep]=4-2-1 timer tick interrupt test in progress or failure. Relocate memory option.

- (35) [Beep]=4-2-2 shutdown test in progress or failure.
- (36) [Beep]=4-2-3 gate A20 failure. Warm start shut down . Configure EMS memory option.
- (37) [Beep]=1-4-2-4 unexpected interrupt in protected mode. Reinitialize the motherboard chipset.
- (38) [Beep]=4-3-1 RAM test in progress or failure above address 0FFFFh
- (38) Shadow system BIOS ROM.(Beep)=1 -4-3-1.Configure wait state option.
- (39) Reinitialize the cache.(Beep)=1 -4-3-1
- (3A) [Beep]=4-3-3 Interval timer channel 2 test in progress or failure.
- (3A) Auto -size cache.(Beep)=1 -4-3-3.Retest 64K base RA M.
- (3B) [Beep]=4 -3-4 Time-Of-Day clock test in progress or failure.
- (3C) [Beep]=4 -4-2 Serial port test in progress or failure.
- (3D) Load alternate registers with CMOS values,(Beep)= 1 -4-4-2
- (3D) [Beep]=4-4-2 Parallel port test in progress or failure.
- (3E) Get switches/jumper status from 8742.
- (3E) [Beep]=4-4-3 Math CoProcessor test in progress or failure.
- (40) Set initial CPU speed.(Beep)=2 -1-1-1.
- (42) Initialize interrupt vectors.(Beep)=2 -1-1-3.
- (44) Initialize BIOS interrupts.(Beep)=2 -1-2-1. Verify video con figuration.
- (45) POST device initialization.
- (46) Check ROM copying notice.(Beep)=2 -1-2-3. Initialize video system.
- (47) Initialize manager for PCI Options ROMs.(Beep)=2 -1- 2-4.
- (48)Check Video configuration against CMOS.(Beep)=2 - 1-3-1. Test for unexpected interrupts.
- (49) Initialize PCI bus and devices.(Beep)=2-1-3-2.
- (4A) Initialize all video adapters in system.(Beep)=2 -1-3-3. Start 2nd protected mode test.
- (4B) Quiet-Boot start(optional).
- (4C) Shadow video BIOS ROM.(Beep)=2 -1 -4-1.Perform LDT instructions test.
- (4E) Display copying notice.(Beep)=2 -1-4-3. Perform TR instruction test.
- (50) Display CPU type and speed.(Beep)=2 -2-1-1.(50)Per- form LSL instruction test.[Beep]=none Custom chip set or custom platform.
- (51) Initialize EISA board.
- (52) Test keyboard.(Beep)=2 -2-1-3.(52)Perform LAR instruction test.
- (54) Set key click if enabled.(Beep)=2 -2-2-1.(54)Perform VERR instruction test.
- (56) Enable keyboard.(Beep)=2-2-2-3.Unexpected exception.
- (58)Test for unexpected interrupts.(Beep)=2 -3-3-.(58) Perform A20 gate test.
- (59) Initialize POST display service.
- (5A) Keyboard ready test. Display prompt "press F2 to enter SETUP".(Beep)=2 -2-3-3
- (5B) Display CPU cache.
- (5C) Test RAM between 512 and 640K.(Beep)=2 -2-4-1. Determine if AT or KT keyboard type.
- (5E) Enter third protected mode test.
- (60) Test expanded memory.(Beep)=2 -3-1-1.(60)Base memory test.
- (62) Test extended memory address lines.(Beep)=2 -3-1-3. Base memory address

test.

- (64) Jump to User Patch 1.(Beep)=2 -3-2-1.Shadow memory test.
- (67)Initialize Multi Processor APIC.
- (68) Enable external and CPU caches.(Beep)=2 -3-3-1. Ex- tended address test.
- (69) Setup System Management Mode(SMM) area.
- (6A) Display external cache size.(Beep)=2 -3-3-3.Determine memory test.
- (6B) Load custom defaults(optional).
- (6C) Display shadow message.(Beep)=2 -3-4-1.Display error messages.
- (6E) Display possible high address for UMB recovery. Display non-disposable segments.(Beep)=2 -3-4-3.Configure ROM/RAM BIOS.
- (70) Display error messages.(Beep)=2 -4-1-1.System time test.
- (72) Check for configuration errors.(Beep)=2 -4-1-3.(72) Real time clock test.
- (74) Test real-time clock.(Beep)=2 -4-2-1.Test for stuck keys.
- (76) Check for keyboard errors. (Beep)=2 -4-2-3.Initialize hardware interrupt vectors.
- (78) Detect and test CoProcessor.
- (7A) Determine/Init COM channels.
- (7C) Set up hardware interrupts vectors.(Beep)=2 -4-4-1.Determine LPT channels.
- (7E) Test CoProcessor if present.(Beep)=2 -4-4-3.Initialize BIOS data area.
- (80) Disable onboard Super I/O ports and IRQs.(Beep)=3 -1- 1-1.Detect floppy controller.
- (81) late POST device initialization.
- (82) Detect and install external RS232 ports.(Beep)=3 -1- 1-3.Test floppy drives.
- (83) Configure non -MCD IDE controllers.
- (84) Detect and install external parallels ports.(Beep)=3 -1- 2-1.Fixed disk test.
- (85) Initialize PC-compatible PnP ISA devices.
- (86) Re-initialize onboard I/O ports.(Beep)=3 -1-2-3.(86)Per form external ROM scan.
- (87) Configure Motherboard Configuration Devices(option - al)
- (88) Initialize BIOS Data Area.(Beep)=3 -1-3-1.Test key- lock/keyboard type.
- (89) Enable Non - Maskable Interrupts (NMIs)
- (8A) Initialize Extended BIOS Data Area.(Beep)=3-1-3-3. wait for F1 test.
- (8B) Test and initialize PS/2 mouse.
- (8C) Initialize floppy controller.(Beep)=3-1-4-1.Final system initialization.
- (8E) Interrupt 19 boot loader.
- (8F) Determine number o f ATA drives(optional)
- (90) Initialize hard -disk controller.(Beep)=3 -2-1-1
- (91) Initialize local-bus hard-disk controller.(Beep)=3 -2-1-2
- (92) Jump to User Patch 2.(Beep)= 3 -2-1-3
- (93) Build MPTABLE for multi processor boards.
- (94) Disable A20 address line.(Beep)=3 -2-2-1
- (95) Install CD ROM for boot.
- (96) Clear huge ES segment register.(Beep)=3 -2-2-3.
- (97) Fix-up Multi Processor table.
- (98) Search for option ROMs. One long, two short beeps on checksum

- failure.(Beep)=3 -2-3 -1.
- (99) Check for SMART Drive(optional).
 - (9A) Shadow option ROMs.(Beep)=3 -2-3-3.
 - (9C) Set up Power Management.(Beep)=3 -2-4-1.
 - (9E) Enable hardware interrupts.(Beep)=3 -2-4-3.
 - (9F) Determine number at ATA and SCSI drives.
 - (A0) Set time of day .(Beep)=3 -3-1-1
 - (A2) Check key lock.(Beep)=3 -3-1-3
 - (A4) Initialize Type matrix.
 - (A8) Erase F2 prompt.(Beep)3 -3-3-1
 - (AA) Scan for F2 key stroke.(Beep)=3 -3-3-3
 - (AC) Enter SETUP.(Beep)=3-3-4-1
 - (AE) Clear in-POST flag.(Beep)=3 -3-4-3.Clear Boot flag.
 - (B0) Check for errors.(Beep)=3 -4-1-1.Unknown interrupt occurred.
 - (B2) POST done-prepare to boot operating system.(Beep)=3- 4-1-3
 - (B4) One short beep before boot.(Beep)=3 -4-3-1
 - (B5) terminate Quiet -Boot(optional)
 - (B6) Check password(optional) .(Beep)=3 -4-2-3
 - (B8) Clear global descriptor table.(Beep)=3 -4-3-4
 - (B9) Prepare boot.
 - (BA) Initialize DMI parameters.
 - (BB) Initialize PnP option ROMs.
 - (BC) Clear parity checkers.(Beep)=3 -4-4-1
 - (BD) Display Multi -Boot menu.
 - (BE) Clear screen(optional).(Beep)=3 -4-4-3
 - (BF) Check virus and backup reminders.(Beep)=3 -4-4-4
 - (C0) Try to boot with INT 19.(Beep)=4 -1-1-1
 - (C1) Initialize POST Error Manager(PEM).
 - (C2) Initialize error logging.
 - (C3) Initialize error display function.
 - (C4) initialize system error handler.
 - (C5) PnP dual CMOS(optional)
 - (C6) Initialize notebook docking (optional).
 - (C7) Initialize notebook docking late.
 - (C8) Force check(optional)
 - (C9) Extended checksum(optional)
 - (D0) Interrupt handler error.(Beep)=4-2-1-1
 - (D2) Unknown interrupt error.(Beep)=4 -2-1-3
 - (D4) Pending interrupt error.(Beep)=4 -2-2-1
 - (D6)Initialize option ROM error.(Beep)4 -2-2-3.Shutdown error.(Beep)=4-2-3-1.(DA)Extended Block Move.(Beep)=4 -2-3-3.(DC)Shutdown 10 error(Beep)=4 -2-4-1
 - (E0) Initialize the chipset.
 - (E1) Initialize the bridge.
 - (E2) Initialize the motherboard chipset, and CPU.(Beep)=4 -3 -1-3
 - (E3) Initialize refresh counter and system timer(Beep)=4 -3- 1 -C4

- (E4) Check for forced Flash or initialize system I/O.(Beep)= 4 -3-2.
 (E5) Check HW status of ROM or check force recovery boot.(Beep)4 -3-2-2.
 (E6) BIOS ROM is OK. (Beep) =4-3-2-3.
 (E7) Do a complete RAM Test or go to BIOS. (Beep)=4 -3-2-4.
 (E8) Do OEM initialization or set huge segment. (Beep)=4 -3-3-1.
 (E9) Initialize interrupt controller or initialize multi processor. (Beep)=4-3-3-2.
 (EA)Read in bootstrap code or initialize OEM special code. (Beep)=4 -3 -3-3.
 (EB) Initialize all vectors or initialize PIC and DMA. (Beep)=4 -3-3-4.
 (EC) Boot the Flash program or initialize memory type. (Beep)=4-3-4-1.
 (ED) Initialize the boot device or initialize memory size. (Beep)=4 -3-4-2
 (EE)Boot code was read OK or shadow boot block.(Beep)= 4 -3-4-3
 (F0)Initialize interrupt vectors.
 (F1) Initialize Run Time Clock.
 (F2) Initialize video.
 (F3) Initialize System Management Mode.
 (F4) Output one beep before DOS.
 (F5) Boot to Mini DOS.(F6)Clear Huge Segment.(F7)Boot to Full DOS.

9. Description of beep code

1) Beep Code Meaning of AMI BIOS Critical Failures

1S	DMA refresh failure	8S	Video memory error
2S	Memory parity error	9S	ROM checksum error
3S	Base 64K RAM failure	10S	CMOS checksum error
4S	System timer not operational	11S	Bad cache memory
5S	Processor failure	Audible code	Non-critical failure
6S	Gate controller A20/keyboard failure	1L 3S	Memory failure
7S	Virtual mode exception error	1L 8S	Display test fails (display data line is loose or video card is unstable)

2) Beep Code Meaning of Award BIOS

1S	System boots normally
2S	Non critical failure, enter CMOS SETUP to reset
1L 1S	RAM or mainboard failure
1L 2S	Video adapter error
1S 3S	Keyboard controller failure
1L 9S	Flash RAM/EPROM (which on the mainboard) failure. (BIOS failure)
High frequency beeps	Memory bank is not plugged well, or bad memory

3) Meanings of Beep for Phoenix BIOS Self test

1S	System boots normally	3S-1S-1S	Register failure
----	-----------------------	----------	------------------

3S	System self test initialization (POST) fails	3S-1S-2S	The second DMA controller failure or register failure
1S-1S-2S	Mainboard failure	3S-1S-3S	INTMSK (interrupt mask register) failure
1S-1S-3S	No power of mainboard battery or CMOS is broken	3S-2S-4S	Keyboard timer failure. Reinstall in CMOS or skip POST
1S-1S-4S	ROM BIOS test failure	3S-3S-4S	Display RAM failure or no RAM, non-fatal failure
1S-2S-1S	System time failure	3S-4S-2S	Display data line loose, video card not plugged well, or video card broken
1S-2S-2S	DMA channel initialization failure	3S-4S-3S	ROM BIOS of video card not found
1S-2S-3S	DMA channel register failure	4S-2S-1S	System real-time clock failure
1S-3S-1S	Memory channel refresh failure (any memory bank)	4S-2S-2S	System start failure, CMOS setting failure or BIOS broken
1S-3S-2S	Base memory failure (memory bank broken or RAM setting failure)	4S-2S-3S	Gate A20 switch in keyboard controller (8042) failure, BIOS can not be switched to protected mode
1S-3S-3S	Base memory failure (maybe the memory bank on the DIMMC slot broken)	4S-2S-4S	Protected mode interrupt failure
1S-3S-4S	Assistant interrupt mask register failure	4S-3S-1S	Memory failure (memory bank broken or RAM setting failure)
1S-4S-1S	Some address of base memory failure	4S-3S-3S	The second clock of system failure
1S-4S-2S	Parity check of system base memory (the first 64k) failure	4S-3S-4S	Real-time clock failure
1S-4S-3S	EISA BUS timer failure	4S-4S-1S	Serial ports (COM port, mouse port) failure
1S-4S-4S	EISA NMI port failure	4S-4S-2S	Parallel ports (or LPT port) failure
2S-1S-1S	System base memory (the first 64k) check failure	4S-4S-3S	Digital coprocessor (8087, 80287, 80387, 80487) failure

L: Long Beep
S: Short Beep

10. Common Problems & Solutions

1) Failures & Solutions (Note: Make all treatments after shutting down the power)

Problems	Reasons	Suggested Solutions
Memory bank	Memory bank not plugged well	Plug it again
	Memory bank broken	Try replacing the memory bank
	The bottom of memory bank dirty	Wipe by rubber or clean by pure ethanol, then try again
	Not matching with other memory banks	Use matching memory banks
Memory slot	Slot dirty and impure	Clean the dirt or impurities

and extended slot	Metal sheet in the slot deformed or broken	Repair by pliers or replace a new slot
	Metal sheet rusted or dirty	Clean it by pure ethanol, remove the rust by other tools or draw and plug times to make them well touch
CPU	CPU bottom dirty or rusty	Replace a new CPU or check the voltage of CPU
	CPU broken	Check the CPU jumper wire and try again after CMOS discharged
	CPU jumper wire setting or CMOS setting failure	Plug it again and check
	CPU not plugged well	Identify PCI and ISA slot carefully
Diagnostic Card problems	Plugged in wrong slot	Correct the side (the side with components face power supply when plugged in ISA slot)
	Plugged in opposite side	Ask for quality warranty from the reseller
	Broken	Plug again times, wipe by rubber, clean by alcohol, or plug in another slot
	Not well plugged or data interface dirty	Please contact our company for solutions
Stop coding	PC Diagnostic Card is not compatible with the main board	Ask for quality warranty from the reseller
	PC Diagnostic Card fault	Plug again times, wipe by rubber, clean by ethanol, or plug in another slot
indicator shows in halves	Mistake! It is impossible for our cards to show codes in halves, maybe it is the user who regard "no" as "half code"	Slot is dusty
		Check the power and CPU jumper wire
		Plug in another slot, and refer to the Must-Reads of Users
		Press the keyswitch over and again, if the "no" appear for the sixth time, the keyswitch is ok, otherwise it is broken. Please contact our company for solution
Bad Keyswitch	Mistake! When the PC diagnostic card receive no codes from mainboard, the LED will remain showing the same code, even if you keep on pressing the check switch . Actually that's not true.	Press harder
	Not enough force on the button	Use less power to press the keyswitch, in order to keep the PC diagnostic card and motherboard touch well
	The PC diagnostic card is not well connected with the mainboard, which is caused by pressing the keyswitch	

2) What does "no" mean? How to solve the problem?

Answer: "no" means the CPU doesn't work, as well as there is no CPU on the mainboard. The suggested solutions are as below

Treatments When New Generation PC Diagnostic Cards and Kingnostics Cards Show "no"

S N	Time to Show "no"	Reasons	Treatments
1	PC power up	CPU is not working yet	Normal condition
2	PC is resetting	CPU stops working during PC resetting	Normal condition

3	CPU overheat protection	A.CPU fan not powerful enough or not plugged well	Change to a powerful CPU fan, and fix it tightly to CPU
		B.Heat sinking silica gel not enough or not good quality	Refill sufficient quality silica gel
		C.Fan is dusty	Clean the fan
		D.CPU is overlocked	Revert the frequency or replace the CPU
		E.Overloaded (pins of) CPU	Test the resistance of the pins of the CPU by multimeter
4	Power switch is not well connected	CPU can not work normally	Replace or repair the power supply
5	Use under high temperature and sunshine	A.CPU under overheating protection	Keep on changing to bigger CPU fans, open the PC case if conditions permitted, blow cool air into the case
		B.Overheated power supply lead to abnormal voltage regulation, which makes the CPU doesn't work	Clean the cooling fan of the power, or use more powerful cooling fans, remove the cards, hard disks, CD-ROM etc., which are not in use currently, or change to higher power supply
		C.other individual component is overheated which make the CPU doesn't work	Find out the components which are not heat-resistant and replace them (don't touch by hand)
		D.High temperature makes both CPU and power unable to work	Lower CPU frequency, use higher power supply, remove the components not in use, exit all software that have nothing to do with current job.
		E.The temperature is too high for most components to work	Keep the PC far from heat resource; use heat insulation equipments; change the heat dissipation direction (away from the computer); use powerful cooling fans or air conditioner; work at nights, or on cloudy or rainy days; lower CPU frequency and use higher power, remove the components not in use, exit all software that have nothing to do with current job.
6	Use under high humidity	Overload the CPU by peripheral circuit	Uncover the computer case, blow hot air into case, and adjust the temperature to the favorite range that can remove the moisture and keep the computer work normally (lower the temperature until the card shows "no" and then heighten the temperature until the card shows "no" again, finally adjust the temperature to the middle point). Please minimize the period that shows "no" in testing.
7	Use in	Bad contact of	Check all fasteners of the computer,

	vibration	hardware caused by vibration may make the CPU unable to work	replace all loose ones or put more nuts to fasten them and enhance their vibration-resistance ability; put spring or leather bottom to the PC, but don't use large size of cotton material, otherwise it will keep the PC overheated; keep the PC away from the vibration resource
8	When testing a normal PC	A.incompatible main board	Consult from Qi Guan factory or email to p678@163.net
		B.Broken Analyzer Card	Send back to Qi Guan factory to repair
9	Others	A.data interface dirty	Wipe by rubber or plug again times
		B.Plugged in wrong slot	Identify PCI and ISA slot carefully
		C.Plug in opposite side	Change the side (face power source when plugged in ISA slot)
		D.There is no code transmitted to the BUS slot, which plugged with Analyzer Card, from the main board.	Plug in another slot with reference to the Must-Reads of Users of this instruction
		E.Main board has not run yet	Check the power resource and CPU jumper wire
		F.Slot is bad contact	Plug again times
		G.Slot is dusty	Clean the slot

3) The new meanings of the old indicator lamps for New Generation PC Diagnostic Cards and Kingnostics Cards

Answer: please see the table below for details

S N	Name of Indicator	Meanings for New Generation PC Diagnostic Cards	Meanings for Kingnostics Cards	Remarks
1	CLK	This indicator light is still kept	Shows the PCI BUS clock signal. It is dynamic and sometimes on when the assembly is busy, and off when the assembly is idle. With ns grade speed, which can not be seen by human eyes. (it is dispensable)	Some cards use radix point of the LED indicator
2	RESET	The same as right	This indicator should be on during resetting and off after resetting. Generally, it is on for a half second then off after PC is restarted. Otherwise it works abnormally	Some cards use radix point of the LED indicator
3	RUN	Only in old cards	It is cancelled because it stops the start code	Some cards use radix point of the LED indicator
4	FRAME	Only in early types	The same with that of CLK	Some cards use radix point of the LED

				indicator
5	3.3V	Power	Special voltage of motherboards that have PCI slot. The indicator will be always on when power on. Part of the motherboards that have PCI slot have no 3.3V voltage, so the indicator is off.	Some cards use radix point of the LED indicator
	-5V	Power	Share the same indicator with 3.3V power. Special -5V voltage of motherboards that have ISA slot. The indicator will be always on when power on, or the motherboard does not have -5V voltage or there is short circuit.	Some cards use radix point of the LED indicator
	LED Indicat or 5V	Power	There must be 5V voltage if the indicator is on.	Some cards use radix point of the LED indicator
	+12V	Power	the indicator will be always on when power on, or there is no 12V voltage or there is short circuit.	Some cards use radix point of the LED indicator
	-12V	Power	the indicator will be always on when power on, or there is no -12V voltage or there is short circuit.	Some cards use radix point of the LED indicator
	CLK	BUS Clock	The CLK will be on when there is clock signal impulse, and will be off when there is no clock signal impulse, no matter the current signal stays at high or low level, which won't mislead the user that there is clock signal impulse.	Some cards use radix point of the LED indicator
	RESET	Reset	It is normal that the indicator light is on for a half second and then is off when start the computer or press the RESET. If the indicator light is never off, usually it is because the Reset Contact Pin on the main board is pinned to the Accelerate Switch or the Reset Circuit is damaged.	Some cards use radix point of the LED indicator
	IRDY	Main parts are not ready	IRDY will flash if there is signal impulse when plug the PC diagnostic card into PCI slot, or it will be off.	Some cards use radix point of the LED indicator
	FRAME	Frame cycle	The Frame will flash if there is frame cycle signal from PCI slot or MiniPCI slot.	Some cards use radix point of the LED indicator

II. Detailed Specification of Diagnostics & Stability-Test Card

1. Components of Diagnostics & Stability-Test Card

(1) Figure of Diagnostics & Stability-Test Card Components (MKCP6 for example)

Connect to the RESET on the case, there is no need to connect the Reset Line to the case if you don't need to use Reset.

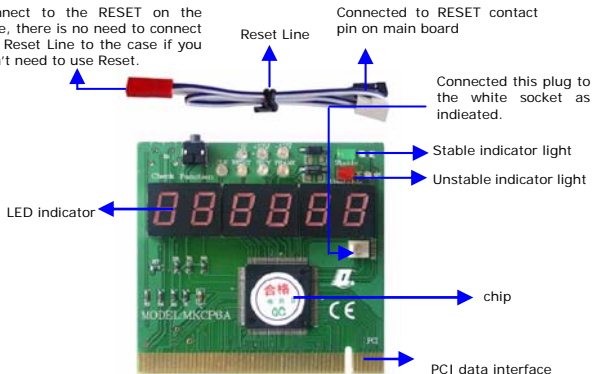

There may be some differences between the real product and the figure, please take the real product as final. Our company will keep upgrading the product without further notice.

(2) Figure of Connection to Main Board

Please pay attention to the connection of the RESET line.

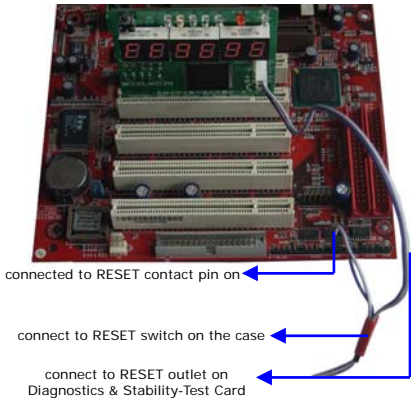

2. Differences and Functional Characteristics of Diagnostics & Stability-Test Cards and Common Analyzer Cards

- (1) The Diagnostics & Stability-Test Card is a kind of high performance card by which not only the PC failure but also its stability can be tested.
- (2) By PC Diagnostic Cards, the hardware problems can be found easily. It helps us to find the causes when the computer works abnormally. No matter you are a developing engineer, a maintenance man or a beginner, or a common user, it shows the PC failures and helps you make rapid and correct treatment.
- (3) The Diagnostics & Stability-Test Card is mainly used for stability test. It can test not only the stability of the stable computers, but also stability of the unstable computers, not matter it is invariable failure or variable failures, such as occasional and invisible potential failures.
- (4) It is helpful for PC and PC accessory selection. It can help users select the high quality computer and spare parts (such as memory bank, hard disk and key board), even the external equipments (such as UPS, printer and computer used for ATM), and help the seller to sell the stable computers at a good price.
- (5) Independent of the RESET signal of the test computer, the abnormal reset logic of the testing computer will not influence the testing. There are also functions such as automatic failure correction and automatic preventing pulse loss. Reset the computer during testing will not influence the stability test.
- (6) The CLK indicator Diagnostics & Stability-Test Card has been thoroughly upgraded, it's 100% correct and will not mislead the users. The users can see the clock pulse fluctuation clearly, even the single 10ns clock pulse. CLK light will not be on when there is no CLK signal impulse, no matter the current signal stays at high or low level. No pulse loss, no unwanted pulse.

3. Explanation of Diagnostics & Stability-Test Card Indicator

LED Name	Function	Description
3V	Power	Special 3V voltage of motherboards that have PCI slot. The indicator will be always on when power on. Part of the motherboards that have PCI slot have no 3.3V voltage, so the indicator is off.
+12V	Power	The indicator will be always on when power on, or the motherboard does not have -5V voltage or there is short circuit.
-12V	Power	The indicator will be always on when power on, or the motherboard does not have -5V voltage or there is short circuit.
CLK	BUS Clock	The CLK will be on when there is clock signal impulse, and will be off when there is no clock signal impulse, no matter the current signal stays at high or low level, which won't mislead the user that there is clock signal impulse.
RESET	Reset	It is normal that the indicator light is on for a half second and then become off when start the computer or press the RESET button. If the indicator light is never off, usually it is because the Reset Contact Pin on the main board is pinned to the Accelerate Switch or the Reset Circuit is damaged
Unstable Indicator	Stability Testing Result Indicator	Light on indicator of the test computer means instability, potential failure or the accessories not matching with the host.
Stable Indicator		The test computer is stable, no potential failure.

4. Testing Status

Both Stable and Unstable indicators on ----- Failure analyzing

The Stable and Unstable indicators flash quickly and alternately - stability testing

The Stable and Unstable indicators flash slowly and alternately - internal data processing of stability test

The Stable indicator on ----- stable

The Unstable indicator on ----- unstable

5. Notice

(1) Connection of RESET Line

Please make sure that the Reset Line (attached) of Diagnostics & Stability-Test Card is well connected before usage. Plug the bigger terminal of the line in the card and the smaller terminal in the RESET contact pin of the testing main board. Plug the RESET line on the main board in the hole at the other end of this line if you need to use RESET switch.

If the Reset Line that connect the Diagnostics & Stability-Test Card and main board is not connected, only failure test will go on, and stability test will not. The indicator light will mislead the user that the test computer is unstable.

(2) Power Cord of Hard Disk

Please remove the power cord from the hard disk before using Diagnostics & Stability-Test Card, because the test computer has to be reset to change the test circuit before starting stability test and avoid damage of data(system files) in the hard disk caused by restarting. Starting the test without removing the power cord from the hard disk means abnormal shutdown, and won't cause any bad results.